



COVALMEX INDUSTRIAL
S.A. DE C.V.
Ingeniería, Pailería, Industria, Sector Agua.

CATÁLOGO 2023

CONEXIONES DE HIERRO MALEABLE



Codo de 90° REF | 150 IBS
Hierro Maleable

MEDIDA	A	B	C	D
1/8"	0,690	0,690	0,208	0,250
1/4"	0,810	0,840	0,210	0,320
3/8"	0,950	1,010	0,230	0,360
1/2"	1,120	1,200	0,250	0,430
3/4"	1,310	1,460	0,270	0,500
1"	1,500	1,770	0,300	0,580
1 1/4"	1,750	2,150	0,340	0,670
1 1/2"	1,950	2,430	0,370	0,700
2"	2,250	2,960	0,420	0,750
2 1/2"	2,700	3,590	0,480	0,920
3"	3,080	4,280	0,550	0,980
4"	3,790	5,400	0,660	1,080
6"	5,130	7,770	0,900	1,280

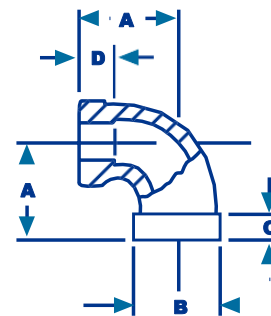

Codo de 45° REF | 150 IBS
Hierro Maleable

MEDIDA	A	B	C	D
1/4"	0,730	0,840	0,210	0,320
3/8"	0,800	1,010	0,230	0,360
1/2"	0,880	1,200	0,250	0,430
3/4"	0,980	1,460	0,270	0,500
1"	1,120	1,770	0,300	0,580
1 1/4"	1,290	2,150	0,340	0,670
1 1/2"	1,430	4,430	0,370	0,700
2"	1,680	2,960	0,420	0,750
2 1/2"	1,950	3,590	0,480	0,920
3"	2,170	4,280	0,550	0,980
4"	2,610	5,400	0,660	1,080

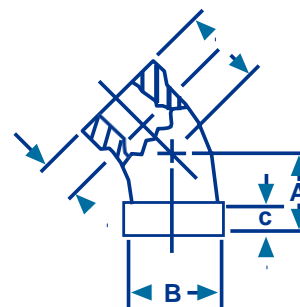

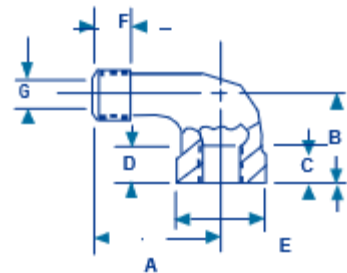

Codo Niple 90° | 150 IBS
Hierro Maleable

MEDIDA	A	B	C	D	E	F	G
1/4"	1,190	0,810	0,210	0,320	0,840	0,400	0,260
3/8"	1,440	0,950	0,230	0,360	1,010	0,410	0,370
1/2"	1,630	1,120	0,250	0,430	1,200	0,530	0,510
3/4"	1,890	1,310	0,270	0,500	1,460	0,550	0,690
1"	2,140	1,500	0,300	0,580	1,770	0,680	0,910
1 1/4"	2,450	1,750	0,340	0,670	2,150	0,710	1,190
1 1/2"	2,690	1,940	0,370	0,700	2,430	0,720	1,390
2"	3,260	2,250	0,420	0,750	2,960	0,760	1,790

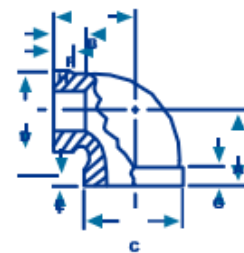

Codo Reducción de 90° | 150 IBS
Hierro Maleable

MEDIDA	A	B	C	D	E	F	G	H
1/2" x 3/8"	1,040	1,030	1,200	1,010	0,430	0,360	0,250	0,230
3/4" x 1/2"	1,200	1,220	1,460	1,200	0,500	0,430	0,270	0,250
1" x 1/2"	1,260	1,360	1,770	1,200	0,580	0,430	0,300	0,250
1" x 3/4"	1,370	1,450	1,770	1,460	0,580	0,500	0,300	0,270
1 1/4" x 3/4"	1,450	1,620	2,150	1,460	0,670	0,500	0,340	0,270
1 1/4" x 1"	1,580	1,670	2,150	1,770	0,670	0,580	0,340	0,300
1 1/2" x 1"	1,650	1,800	2,430	1,770	0,700	0,580	0,370	0,300
1 1/2" x 1 1/4"	1,820	1,880	2,430	2,150	0,700	0,670	0,370	0,340
2" x 1 1/4"	1,900	2,100	2,960	2,150	0,750	0,670	0,420	0,340
2" x 1 1/2"	2,020	2,160	2,960	2,430	0,750	0,700	0,420	0,370

Codo Retorno

150 IBS
Hierro Maleable

MEDIDA	A	B	C	D
1/2"	1,500	1,200	0,250	0,430
3/4"	2,000	1,460	0,270	0,500

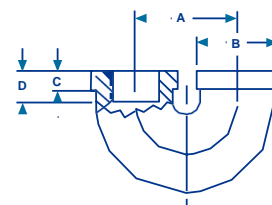

Codo Rincón

150 IBS
Hierro Maleable

MEDIDA	A	B	C
1/2"	1,10	1,000	0,43
3/4"	1,300	1,290	0,50
1"	1,500	1,520	0,58

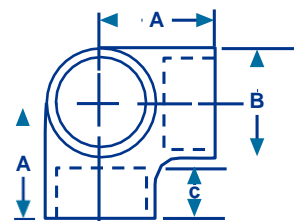

Cople Reforzado

150 IBS
Hierro Maleable

MEDIDA	A	B	C	D
1/4"	1,060	0,840	0,210	0,320
3/8"	1,160	1,010	0,230	0,360
1/2"	1,340	1,200	0,250	0,430
3/4"	1,520	1,460	0,270	0,500
1"	1,670	1,770	0,300	0,580
1 1/4"	1,930	2,150	0,340	0,670
1 1/2"	2,180	2,430	0,370	0,700
2"	2,530	2,960	0,420	0,750
2 1/2"	2,680	3,590	0,480	0,920
3"	3,180	4,280	0,550	0,980
4"	3,690	5,400	0,660	1,080

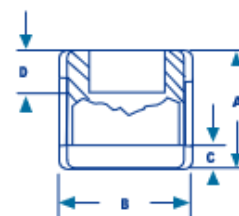

Cruz Reforzada

150 IBS
Hierro Maleable

MEDIDA	A	B	C	D
1/2"	1,120	1,200	0,250	0,430
3/4"	1,310	1,460	0,270	0,500
1"	1,500	1,770	0,300	0,580
1 1/4"	1,750	2,150	0,340	0,670
1 1/2"	1,940	2,430	0,370	0,700
2"	2,250	2,960	0,420	0,750
2 1/2"	2,700	3,590	0,480	0,920
3"	3,080	4,280	0,550	0,980
4"	3,790	5,400	0,660	1,080

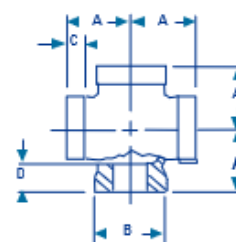

Reducción Bushing

150 IBS
Hierro Maleable

MEDIDA	A	B	C	D
3/8 x 1/8"	0,480	0,250	0,680	0,160
3/8 x 1/4"	0,480	0,40	0,680	0,160
1/2 x 1/4"	0,560	0,320	0,870	0,190
1/2 x 3/8"	0,560	0,410	0,870	0,190
3/4 x 1/4"	0,630	0,320	1,150	0,220
3/4 x 3/8"	0,630	0,360	1,150	0,220
3/4 x 1/2"	0,630	0,530	1,150	0,220
1 x 1/4"	0,750	0,320	1,120	0,300
1 x 3/8"	0,750	0,360	1,120	0,300
1 x 1/2"	0,750	0,430	1,420	0,250
1 x 3/4"	0,750	0,500	1,420	0,250
1 1/4 x 1/2"	0,800	0,430	1,340	0,340
1 1/4 x 3/4"	0,800	0,500	1,760	0,280
1 1/4 x 1"	0,800	0,580	1,760	0,280
1 1/2 x 1/2"	0,830	0,430	1,340	0,370
1 1/2 x 3/4"	0,830	0,500	1,630	0,370
1 1/2 x 1"	0,830	0,580	2,000	0,310
1 1/2 x 1	0,830	0,710	2,000	0,310
2 x 1/2"	0,880	0,430	1,340	0,410
2 x 3/4"	0,880	0,500	1,630	0,410
2 x 1"	0,880	0,580	1,950	0,410
2 x 1 1/4"	0,880	0,670	2,480	0,340
2 x 1 1/2"	0,880	0,700	2,480	0,340
2 1/2 x 1"	1,070	0,580	1,950	0,440
2 1/2 x 1	1,070	0,670	2,390	0,440
2 1/2 x 1	1,070	0,700	2,680	0,440
2 1/2 x 2"	1,070	0,750	2,980	0,370
3 x 1"	1,130	0,580	1,950	0,480
3 x 1 1/4"	1,130	0,670	2,390	0,480
3 x 1 1/2"	1,130	0,700	2,680	0,480
3 x 2"	1,130	0,750	3,280	0,480
3 x 2 1/2"	1,130	0,920	3,860	0,400
4 x 1"	1,220	0,580	1,950	0,600
4 x 1 1/4"	1,220	0,670	2,390	0,600
4 x 1 1/2"	1,220	0,700	2,680	0,600
4 x 2"	1,220	0,750	3,280	0,600
4 x 2 1/2"	1,220	0,920	3,860	0,600
4 x 3"	1,220	0,980	4,620	0,500
6 x 2"	1,400	0,750	3,280	0,750
6 x 2 1/2"	1,400	0,920	3,860	0,750
6 x 3"	1,400	0,980	4,620	0,750
6 x 4"	1,400	1,080	5,790	0,750

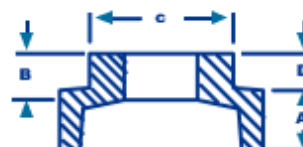
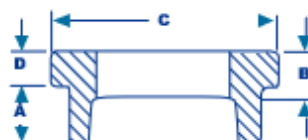

Reducción Campana

150 IBS
Hierro Maleable

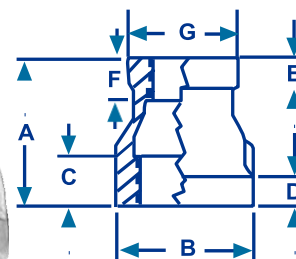

TAMAÑO	A	B	C	D	E	F	G
3/8 x 1/4"	1,130	1,010	0,360	0,230	0,210	0,320	0,840
1/2 x 1/4"	1,250	1,200	0,430	0,250	0,210	0,320	0,840
1/2 x 3/8"	1,250	1,200	0,430	0,250	0,230	0,360	1,010
3/4 x 1/4"	1,440	1,460	0,500	0,270	0,210	0,320	0,840
3/4 x 3/8"	1,440	1,460	0,500	0,270	0,230	0,360	1,010
3/4 x 1/2"	1,440	1,460	0,500	0,270	0,250	0,430	1,200
1 x 1/4"	1,690	1,770	0,580	0,300	0,210	0,320	0,840
1 x 3/8"	1,690	1,770	0,580	0,300	0,230	0,360	1,010
1 x 1/2"	1,690	1,770	0,580	0,300	0,250	0,430	1,200
1 x 3/4"	1,690	1,770	0,580	0,300	0,270	0,500	1,460
1 1/4 x 1/2"	2,060	2,150	0,670	0,340	0,250	0,430	1,200
1 1/4 x 3/4"	2,060	2,150	0,670	0,340	0,270	0,500	1,460
1 1/4 x 1"	2,060	2,150	0,670	0,340	0,300	0,580	1,770
1 1/2 x 1/2"	2,310	2,430	0,700	0,370	0,250	0,430	1,200
1 1/2 x 3/4"	2,310	2,430	0,700	0,370	0,270	0,500	1,460
1 1/2 x 1"	2,310	2,430	0,700	0,370	0,300	0,580	1,770
1 1/2 x 1 1/4"	2,310	2,430	0,700	0,370	0,340	0,670	2,150
2 x 1/2"	2,810	2,960	0,750	0,420	0,250	0,430	1,200
2 x 3/4"	2,810	2,960	0,750	0,420	0,270	0,500	1,460
2 x 1"	2,810	2,960	0,750	0,420	0,300	0,580	1,770
2 x 1 1/4"	2,810	2,960	0,750	0,420	0,340	0,670	2,150
2 x 1 1/2"	2,810	2,960	0,750	0,420	0,370	0,700	2,430
2 1/2 x 1/2"	3,250	3,590	0,920	0,480	0,250	0,430	1,200
2 1/2 x 2"	3,250	3,590	0,920	0,480	0,420	0,750	2,960
3 x 2	3,690	4,280	0,980	0,550	0,420	0,750	2,960
3 x 2 1/2	3,690	4,280	0,980	0,550	0,480	0,920	3,590
4 x 3	4,380	5,400	1,080	0,660	0,550	0,980	4,280

Tapón Cachucha

150 IBS
Hierro Maleable

MEDIDA	A	B	C	D
3/8"	1,010	0,740	0,360	0,230
1/2"	1,200	0,870	0,430	0,250
3/4"	1,460	0,970	0,500	0,270
1"	1,770	1,160	0,580	0,300
1 1/4"	2,150	1,280	0,670	0,340
1 1/2"	2,430	1,330	0,700	0,370
2"	2,460	1,450	0,750	0,420
2 1/2"	3,590	1,700	0,920	0,480
3"	4,280	1,800	0,980	0,550
4"	5,400	2,080	1,080	0,660

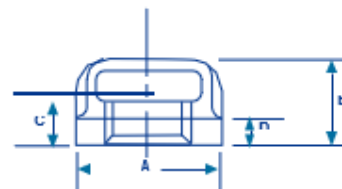

Tapón Macho

150 IBS
Hierro Maleable

MEDIDA	A	B	C	D
3/8"	0,480	0,310	0,4375	-
1/2"	0,560	0,38	0,5625	-
3/4"	0,630	0,440	0,6250	-
1"	0,750	0,500	0,8125	-
1 1/4"	0,800	0,560	0,9375	-
1 1/2"	0,830	0,620	1,1250	-
2"	0,880	0,680	1,3125	-
2 1/2"	1,070	0,740	1,5000	-
3"	1,130	0,800	1,6875	-
4"	1,220	1,000	-	0,880
6"	1,400	1,250	-	1,250



CABEZA CUADRADA 3/8" - 3"
CABEZA CON RANURAS 4" - 6"

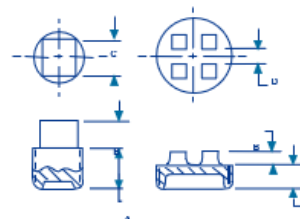

TEE Reforzada

150 IBS
Hierro Maleable

MEDIDA	A	B	C	D
1/4"	0,810	0,320	0,210	0,840
3/8"	0,950	0,360	0,230	1,010
1/2"	1,120	0,430	0,250	1,200
3/4"	1,310	0,500	0,270	1,460
1"	1,500	0,580	0,300	1,770
1 1/4"	1,750	0,670	0,340	2,150
1 1/2"	1,950	0,700	0,370	2,430
2"	2,250	0,750	0,420	2,960
2 1/2"	2,700	0,920	0,480	3,590
3"	3,080	0,980	0,550	4,280
4"	3,790	1,080	0,660	5,400
6"	5,130	1,280	0,900	7,770

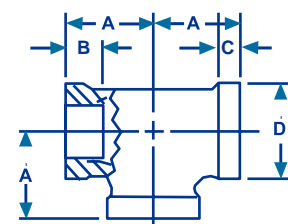

TEE Rincón

150 IBS
Hierro Maleable

MEDIDA	A	B	C
1/2"	1,10	1,1400	0,4300
3/4"	1,3000	1,3900	0,5000
1"	1,5000	1,7050	0,5800

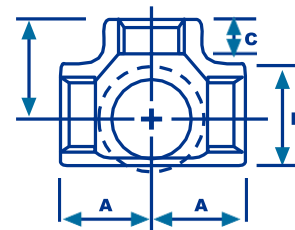

TEE Reducción

150 IBS
Hierro Maleable

TAMAÑO	A1	A2	A3	B1	B2	C1	C2	D1	D2
3/4 x 1/2"	1,200	1,200	1,220	0,500	0,430	0,270	0,250	1,460	1,200
1 x 3/4"	1,370	1,370	1,450	0,580	0,500	0,300	0,270	1,770	1,460
1 x 1/2"	1,260	1,260	1,360	0,580	0,430	0,300	0,250	1,770	1,200
1 1/2 x 1"	1,650	1,650	1,800	0,700	0,580	0,370	0,300	2,430	1,770
2 x 1/2"	1,500	1,500	1,870	0,750	0,430	0,480	0,250	2,960	1,200
2 x 1 1/2"	2,020	2,020	2,160	0,750	0,700	0,480	0,370	2,960	2,430

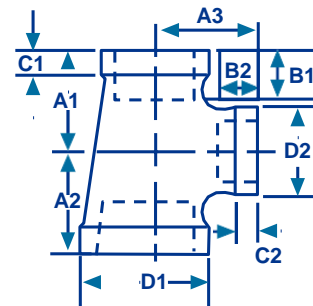

Tuerca Presión

150 IBS
Hierro Maleable

MEDIDA	A	B	C	D
1/2"	0,310	0,970	0,180	0,060
3/4"	0,340	1,230	1,430	0,060
1"	0,380	1,500	1,750	0,060
1 1/4"	0,420	1,860	2,100	0,060
1 1/2"	0,470	2,120	2,350	0,060
2"	0,530	2,630	2,880	0,090

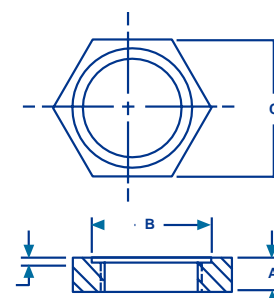

Tuerca Unión

150 IBS
Hierro Maleable

MEDIDA	A	B	C
1/4"	1,290	1,440	0,560
3/8"	1,440	1,610	0,630
1/2"	1,760	1,790	0,700
3/4"	1,960	2,020	0,712
1"	2,160	2,120	0,780
1 1/4"	2,750	2,260	0,860
1 1/2"	2,990	2,440	0,880
2"	3,620	2,750	1,000
2 1/2"	4,540	3,260	1,200
3"	5,060	3,530	1,220
4"	6,080	3,950	1,430

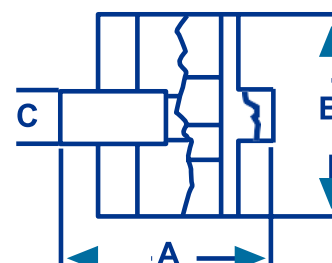
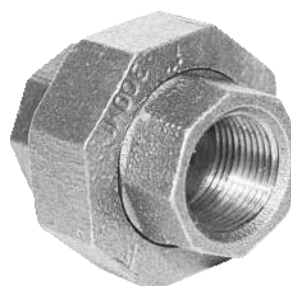

Y Griega

150 IBS
Hierro Maleable

MEDIDA	A	B	C	D
1/2"	1,710	1,710	0,610	2,320
3/4"	2,050	2,050	0,720	2,770
1"	2,430	2,430	0,850	3,280
1 1/4"	2,920	2,920	1,020	3,940
1 1/2"	3,280	3,280	1,100	4,380
2"	3,930	3,930	1,240	5,170
2 1/2"	4,730	4,730	1,520	6,250
3"	5,550	5,550	1,710	7,260
4"	6,970	6,970	2,010	8,980

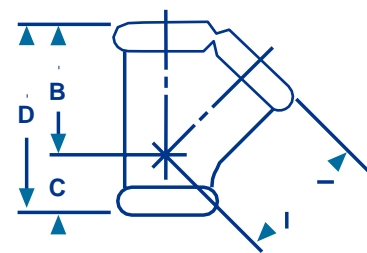

Cople Liso

150 IBS
Hierro Maleable

MEDIDA	A	B	C
3/8"	1,160	0,360	0,870
1/2"	1,340	0,430	1,050
3/4"	1,520	0,500	1,318
1"	1,670	0,580	1,605
1 1/4"	1,930	0,670	1,950
1 1/2"	2,150	0,700	2,375
2"	2,530	0,750	2,575
2 1/2"	2,880	0,920	3,320
3"	3,180	0,980	3,950
4"	3,690	1,080	5,080

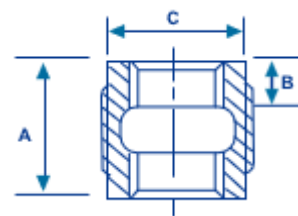

Codo de 90° REF

300 IBS
Hierro Maleable

MEDIDA	A	B	C	D	E
3/8"	1,060	1,120	0,440	0,470	0,150
1/2"	1,250	1,340	0,500	0,570	0,160
3/4"	1,440	1,630	0,560	0,640	0,180
1"	1,630	1,950	0,620	0,750	0,200
1 1/4"	1,940	2,390	0,690	0,840	0,220
1 1/2"	2,130	2,680	0,750	0,870	0,240
2"	2,500	3,280	0,840	1,000	0,260
2 1/2"	2,940	3,860	0,940	1,170	0,310
3"	3,380	4,620	1,000	1,230	0,350
4"	4,442	5,955	1,181	1,425	0,460

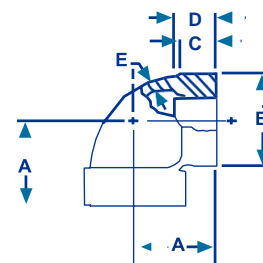

Codo de 45° REF

300 IBS
Hierro Maleable

MEDIDA	A	B	C	D	E
1/2"	1,000	1,340	0,500	0,570	0,16
3/4"	1,130	1,630	0,560	0,640	0,18
1"	1,310	1,950	0,620	0,750	0,20
1 1/4"	1,500	2,390	0,690	0,840	0,22
1 1/2"	1,690	2,680	0,750	0,870	0,24
2"	2,000	3,280	0,840	1,000	0,26

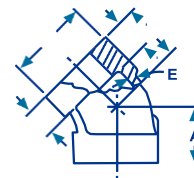

Cople Reforzado

300 IBS
Hierro Maleable

MEDIDA	A	B	C	D	E
1/2"	1,870	1,340	0,500	0,570	0,16
3/4"	2,120	1,630	0,560	0,640	0,18
1"	2,370	1,950	0,620	0,750	0,2
1 1/4"	2,870	2,390	0,690	0,840	0,22
1 1/2"	2,870	2,680	0,750	0,870	0,24
2"	3,620	3,280	0,840	1,000	0,26

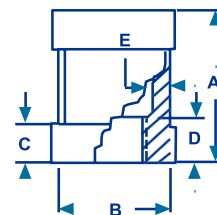

Tapón Cachucha

300 IBS
Hierro Maleable

MEDIDA	A	B	C	D	E
1/2"	0,980	1,340	0,500	0,570	0,16
3/4"	1,080	1,630	0,560	0,640	0,18
1"	1,260	1,950	0,620	0,750	0,2
1 1/4"	1,380	2,390	0,690	0,840	0,22
1 1/2"	1,430	2,680	0,750	0,870	0,24
2"	1,680	3,280	0,840	1,000	0,26

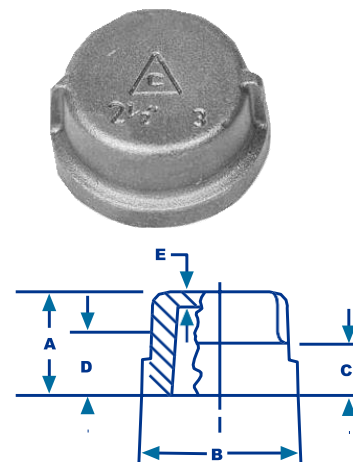

TEE Reforzada

300 IBS
Hierro Maleable

MEDIDA	A	B	C	D	E
3/8"	1,060	1,120	0,440	0,470	0,150
1/2"	1,250	1,340	0,500	0,570	0,160
3/4"	1,440	1,630	0,560	0,640	0,180
1"	1,630	1,950	0,620	0,750	0,200
1 1/4"	1,940	2,390	0,690	0,840	0,220
1 1/2"	2,130	2,680	0,750	0,870	0,240
2"	2,500	3,280	0,840	1,000	0,260
2 1/2"	2,940	3,860	0,940	1,170	0,310
3"	3,380	4,620	1,000	1,230	0,350
4"	4,600	5,930	1,110	1,300	0,460

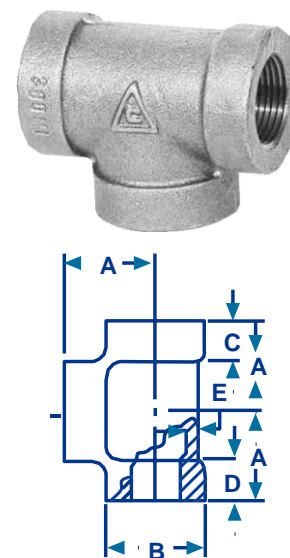

Tuerca Unión

300 IBS
Hierro Maleable

MEDIDA	A	B
1/2"	1,810	1,760
3/4"	2,120	2,150
1"	2,310	2,480
1 1/4"	2,660	3,020
1 1/2"	2,850	3,280
2"	3,230	3,960

